

# Preface

---

Repairing a fountain pen is not as simple as it seems. It might be compared to repairing a watch. It is easy to tinker with a watch with the result that it keeps poor time or no time at all; and it is easy to tinker with a fountain pen so that it gives the poorest kind of satisfaction or no satisfaction at all.

No one should attempt to repair or to adjust a fountain pen until he is familiar with the mechanical characteristics of that pen. With the help of the directions in this service manual, a dealer can quite easily remedy the ordinary complaints made by a customer.

In a great many of the cases when a customer claims that ink does not flow properly in a fountain pen, the reason for it is that the owner of the pen has failed to observe the simplest rule laid down in the instructions concerning fountain pens—namely, to keep the pen point covered and the cap screwed down tightly over it. When the point is left exposed, the molecules of water in the ink are constantly being drawn into the dry air and eventually nothing but dried ink is left around the pen. Naturally, a pen with a dry point cannot write satisfactorily. All of the dried ink around the pen point and feed must again be wet and the solid matter removed before the pen can again write properly.

If a pen is brought to you in this condition, and the owner claims it is “no good” and that he has “not abused” it, but has used it according to directions, a simple way to get the pen in working condition is to stand the pen, point downward, in a glass of clear water for an hour or two. You will be surprised to see the amount of sediment that goes to the bottom of the glass by this simple treatment.

Some people are so thoughtless as to take hold of the nib of the pen with a pair of pliers and attempt to pull it out in this way. Ordinarily this cracks the iridium from the gold and, in any event, it is certain to damage the pen.

It should be borne in mind that a pen is a delicate writing instrument and will obey the laws of natural physics if given the opportunity, but it must have fairly intelligent treatment in order to function as both the owner and manufacturer expect it to do.

The following pages are written not for the general public but as a guide for our dealers. The information conveyed in these pages will enable you to do many small repair jobs in your own store while the customer waits, instead of sending the pen to the factory.

This Service Manual is written and prepared for your benefit with the thought in mind that you may be able to give your customers the best kind of service.

You will find, after you acquire the knowledge to do this work, that it is exceedingly interesting and it will enable you to give to your customers that extra accommodation which will bring additional business to you in return for the service you supply.

# Index

---

	Page
To Fill The Parker Vacumatic Pen .....	6
When To Refill .....	7
Parts of the Parker Vacumatic Pen .....	8, 9
X-Ray Photograph of Parker Vacumatic.....	10
The Vacumatic Fitting Block .....	11
To Remove The Vacumatic Filler Unit .....	12
To Install A New Filler Unit .....	13
To Exchange Nib Sections of Vacumatic Pens .....	14
To Remove The Gold Nib .....	15
Vacumatic Feeds .....	16
To Fit A New Nib and Feed .....	17
To "Set" A Newly Fitted Gold Nib .....	18
To Regulate The Flow of Ink .....	19
To Refinish or Smooth Up The Iridium Tip .....	20
To Remove The Clip Screw .....	21
Parts of the Parker Duofold Pen .....	22
To Fill Parker Duofold Pen .....	23
To Remove The Pressure Bar .....	24
Sacs .....	25
Pressure Bars .....	26
To Insert The Pressure Bar .....	27
Leaking .....	28
Proper Care of Your Fountain Pen .....	29
Repair Tool Kit No. 966 .....	30, 31
Quink Keeps A Pen Clean .....	32
Parts of the Parker Pencil .....	33
Parker Desk Sets .....	34
To Attach The Retainer To The Base .....	35
The Parker Desk Set in Operation .....	36

## TO FILL THE PARKER VACUMATIC PEN

1—Unscrew the small cap at the end of barrel, thus exposing the plunger button.

2—Release the filler plunger by pressing it and turning it slightly to the left. Plunger will extend.

3—Immerse the pen point in ink, as shown in the illustration, and depress the filler plunger. Pause for a second at the end of the downward stroke to permit all the air inside the barrel to be expelled.

4—Release the filler plunger by removing the thumb, and pause again for a second to allow the vacuum created inside the barrel to drink in the full swallow of ink, before making the next downward stroke.

5—Repeat the strokes (down and up) until the pen is filled. About 7 strokes are required for the standard model—12 strokes for the over-size model.

You can "feel" when the pen is filled, as then it is harder to work the plunger.

Before removing pen from bottle, depress the filler plunger and re-engage it by turning the button to the right. Replace the small cap.

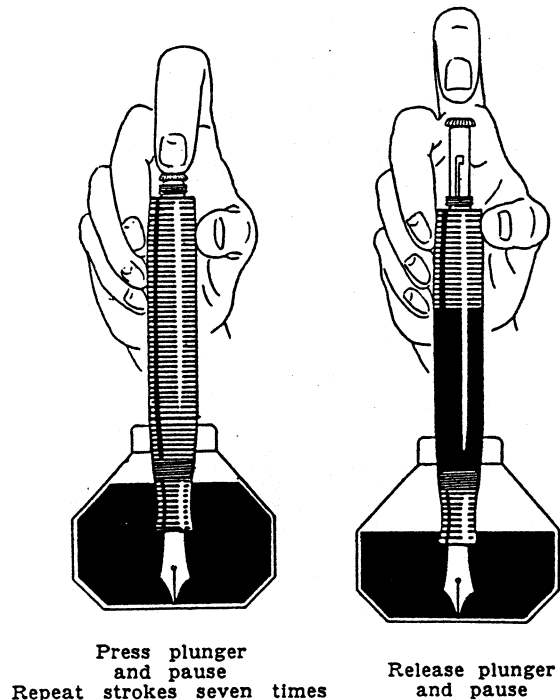
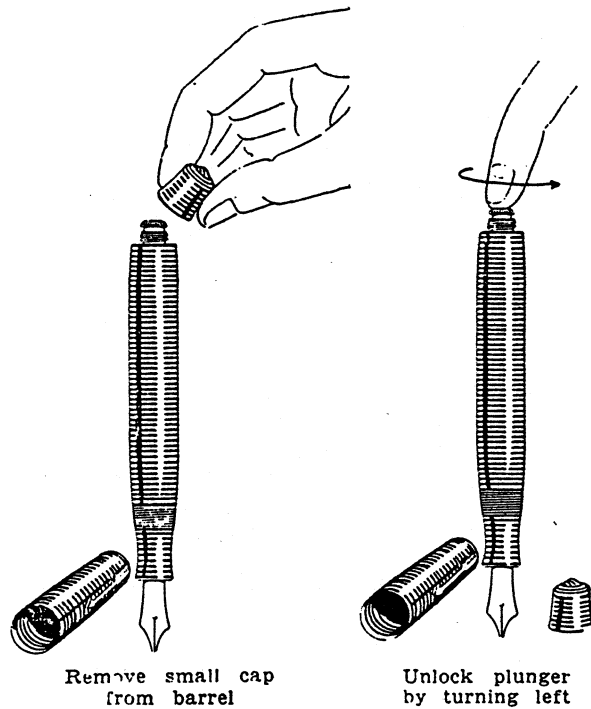

## WHEN TO REFILL

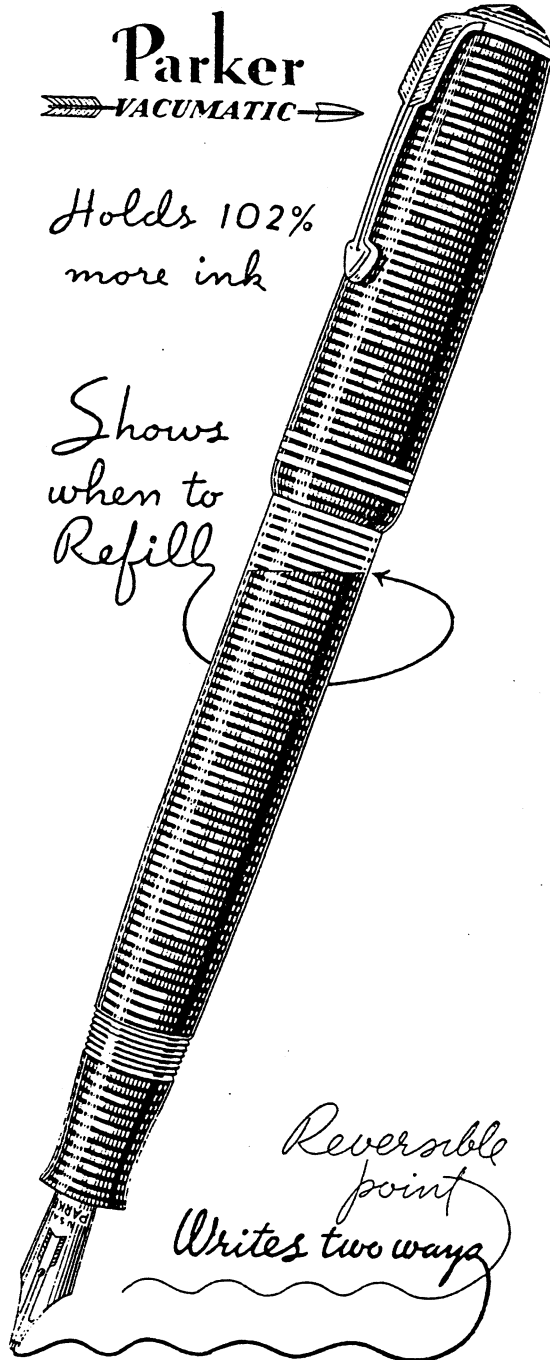

All transparent models, when held to the light, show the quantity of ink indicating to the user when to refill and thus ending the inconvenience caused by a pen running dry in the midst of writing.

Although the ink cannot be seen within the opaque model, the user will be able to know when to refill. When the pen is about 9/10ths empty, ink will feed to the nib more rapidly than usual. This is the signal to refill.

Keep the outer cap screwed tightly on the pen when not in use. This will keep the pen point always moist and ready for immediate use.

Never flush the pen with hot water, alcohol, acids or anything except cold water. Anything but cold water is almost certain to damage the pen.

## To Empty The Pen

To empty the Parker VACUMATIC Pen, release the filler plunger and push it down very slowly. The slow pressure allows the ink to be expelled in drops. Release the plunger and repeat until the pen is empty.

It is necessary to clean the fountain pen from time to time in order to keep it in good condition. Fill the pen with water and let it stand point down in a glass of water over night. This dissolves and removes all ink crusts.

## PARTS OF THE PARKER VACUMATIC PEN

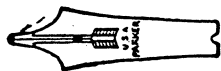

Gold Nib  
 Oversize 4.50 list  
 Standard & Slender 3.50  
 Junior 2.00

Gold Nib. Made of 14-karat gold, plated with platinum, tipped with highest quality iridium. This iridium will show no wear after many years of service.

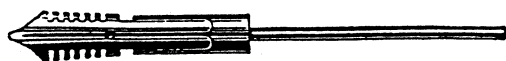

Tube Feed .30 list

Tube Feed. Both feed and breather tube are made of fine hard rubber.



Section  
 Oversize .30 list  
 Standard & Slender .30  
 Junior .20

Section. Made of laminated, unbreakable pyroxylin.

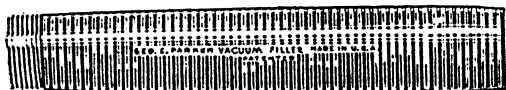

Barrel  
 Oversize 1.80 list  
 Standard & Slender 1.20  
 Junior .80

Barrel. Made of laminated unbreakable pyroxylin. Patented by and therefore exclusive with Parker.



Filler Unit .90 list  
 3 sizes  
 Oversize - Standard - Slender

Filler Unit. Main parts are made of brass, chromium plated. The spring is stainless steel. The threaded bushing which screws into the barrel is aluminum.

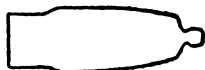

Diaphragm 10c list  
 3 sizes  
 Oversize - Standard - Slender

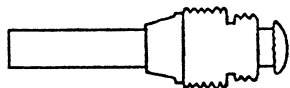

Filling Mechanism 80c list  
 3 sizes  
 Oversize - Standard - Slender

The filler unit consists of the filling mechanism and the diaphragm.

PARTS OF THE PARKER VACUMATIC PEN

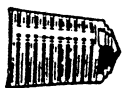

Blind Cap  
 Oversize .50 list  
 Standard & Slender .40  
 Junior .20

Blind Cap. Made of laminated unbreakable pyroxylin. The unit consists of blind cap proper, band and clip screw. The band is covered with rolled gold.



Outer Cap  
 Oversize 1.70 list  
 Standard & Slender 1.10  
 Junior .70

Outer Cap. Made of laminated unbreakable pyroxylin, mounted with gold plated bands, yellow or white gold. The inside is fitted with an inner cap which provides an air-tight chamber for the nib when the pen is closed.

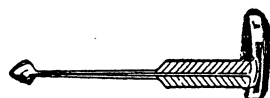

Clip .60 list  
 3 sizes  
 Oversize - Standard - Slender

Clip. Made of optical spring metal covered with rolled gold.

White gold clips are covered with rolled gold. In addition they are plated with chromium for protection and higher luster.



Ring Crown, Slender Size .60 list

Ring Crown. Made of optical spring metal covered with rolled gold.



Clip Screw .15 list  
 3 sizes  
 Oversize - Standard - Slender

Clip Screw. Made of pyroxylin. To reinforce it against shrinkage, a rubber plug is fitted inside. Its use in holding clip allows the pen to set low in the pocket.

## X-RAY PHOTOGRAPH OF PARKER VACUMATIC

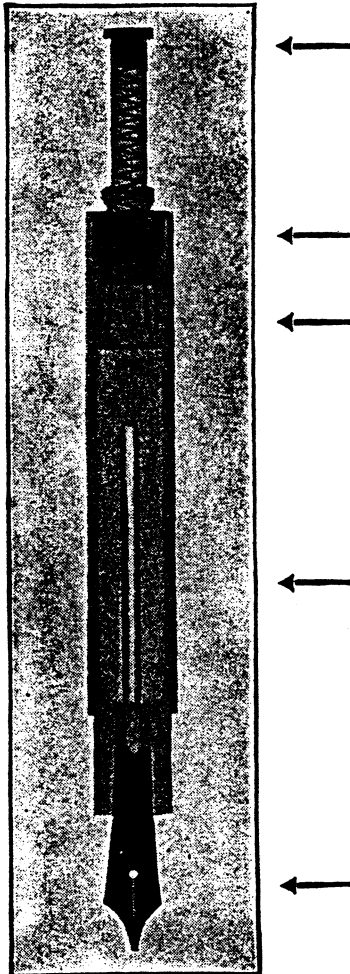

The plunger of the filler unit is released, showing the stainless steel spring contained therein.

The dark portion is the threaded bushing of aluminum by which the filler unit is screwed into the barrel.

The lighter portion is the rubber diaphragm, attached to the filling mechanism.

In the center is the breather tube, through which ink enters and air escapes during the filling process.

The breather tube is inserted into the feed and connects with the airhole in the nib.

The VACUMATIC pen point is made of solid 14-karat gold, plated with platinum, and tipped with the highest grade iridium.

The Parker VACUMATIC contains no ordinary rubber sac, no piston, no valves, no packing. For that reason it will outlast any sac-filling fountain pen and should easily last a lifetime.

## THE VACUMATIC FITTING BLOCK

The Vacumatic Fitting Block is a new precision instrument in which several tools for fitting the Vacumatic pen have been combined. It is made of fine tool steel: the great amount of machine tooling necessary in its manufacture makes it a costly instrument. We are offering it at only a part of our own cost to enable each dealer to acquire it.

The size of the Vacumatic Fitting Block is 2 x 2 x  $\frac{3}{4}$ "; the net weight is 12 ounces; the price is \$1.50 net.

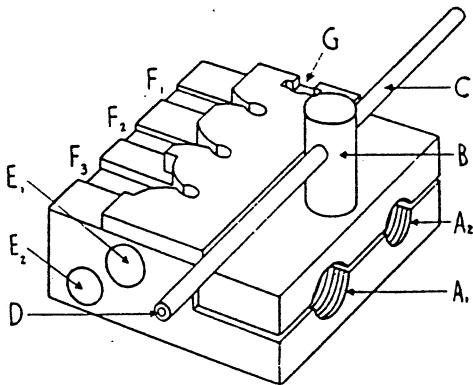

Vacumatic Fitting Block  
\$1.50 net

A is a clamp wrench for removing and installing the Vacumatic filler unit.

A-1 for Standard and Slender size Vacumatic pens.

A-2 for Oversize Vacumatic pens.

B is the turn screw by which the clamp wrench is tightened.

C is the driver used for expelling feeds.

D is the channel in the driver which slips over the breather tube of the feed.

E is the collar used in combination with driver for expelling feeds.

E-1 is for Slender and Standard Vacumatic pens.

E-2 is for Oversize Vacumatic pens.

F is the fitting groove for fitting gold nibs.

F-1 is for Lady or Slender size.

F-2 is for Junior or Standard Size.

F-3 is for Senior or Oversize.

G is a button puller for Duofold pens.

H on the under side of the fitting block (not shown) is a rubber disc used for loosening or tightening clip screw of Vacumatic pens.



## TO REMOVE THE VACUMATIC FILLER UNIT

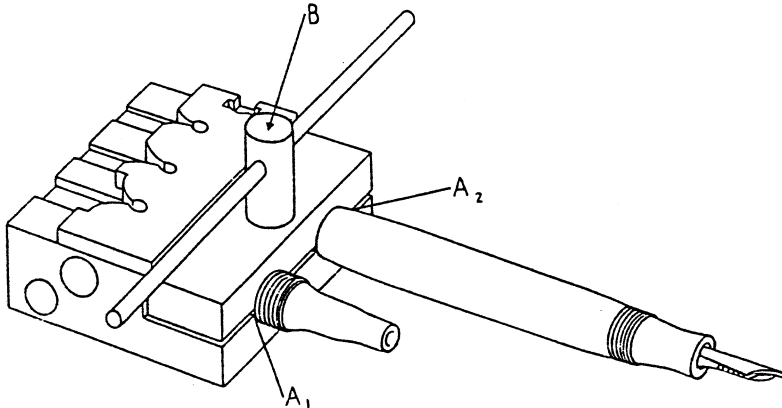

Remove the Blind Cap from the pen. Open the jaws of the clamp wrench A by turning the turn screw B. Insert the end of the filler unit which protrudes from the barrel and screw it into the hole "A."

Tighten the clamp wrench by means of the turn screw B, grasp the pen firmly in your right hand, give it a sharp twist to the left to loosen the filler unit and screw off the barrel.

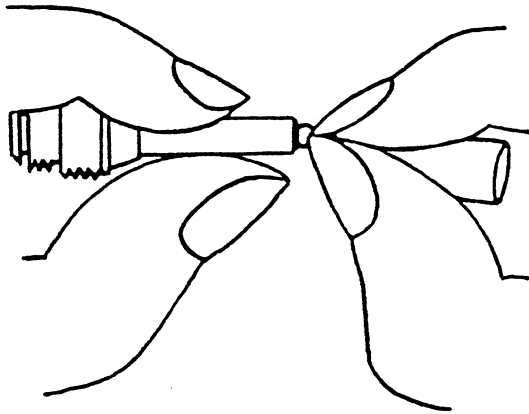

After removal of the old filler unit, brush out and clean the threads inside the barrel.

## TO INSTALL A NEW DIAPHRAGM

To insert the diaphragm requires a little practice. In the nipple of the diaphragm is a small rubber pellet. Grasp the diaphragm firmly just back of the nipple between the nails of the thumb and forefinger, tightening the nipple over the pellet as much as possible. This reduces the diameter of the nipple so that it will pass through the hole in the plunger.

When inserting the nipple into the plunger, use a slight twisting motion, as if to screw it in, and, at the same time, press the nipple into place.

After the nipple has been entirely inserted in the plunger, fold the diaphragm back over the plunger to its correct position. This is done simply by turning the diaphragm inside out and pushing it up on the plunger.

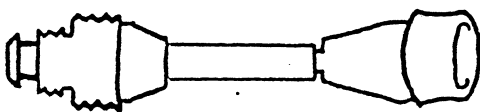
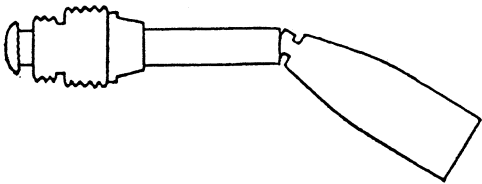

## TO INSTALL A NEW FILLER UNIT

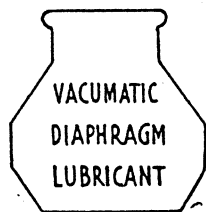
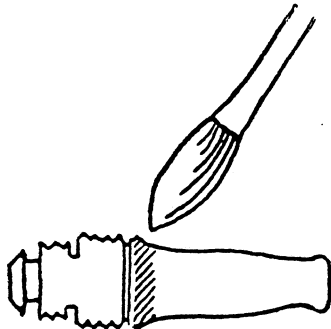

Small Bottle of  
Diaphragm Lubricant  
5c net

With a fine brush, apply some diaphragm lubricant to the upper part of the diaphragm as indicated by the shaded part in the illustration.

This lubricant prevents the diaphragm from sticking to the wall of the barrel because of friction, and from becoming twisted when the filler unit is screwed tightly into the barrel. Use only a very little lubricant, just enough to allow the diaphragm to turn evenly with the rest of the filler unit.

The Diaphragm lubricant is furnished in small bottles at a net price of 5c each. This lubricant consists of:

30 parts Gum Tragacanth  
1 part Phenol  
dissolved in 1,000 parts Water

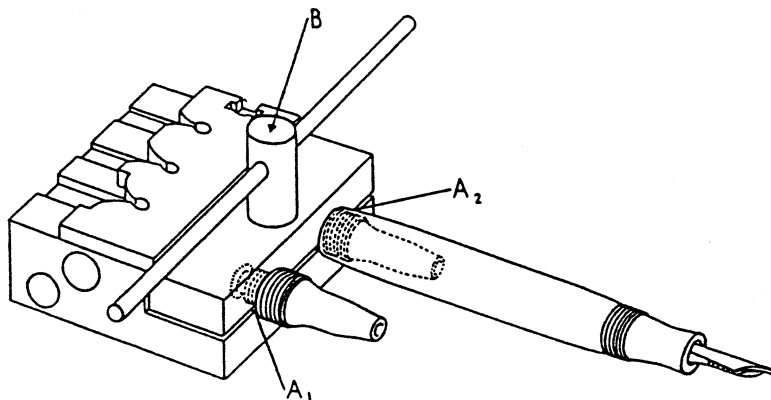

Insert the filler unit into the clamp wrench "A". With a match stick or a tooth pick, apply a little Vacumatic cement to the threads of the filler unit which go into the barrel, and screw the barrel over the filler unit.

The Vacumatic cement makes a leak-proof seal. It is non-drying and, therefore, allows the filler unit to be removed again should this be necessary.

## TO EXCHANGE NIB SECTIONS OF VACUMATIC PENS

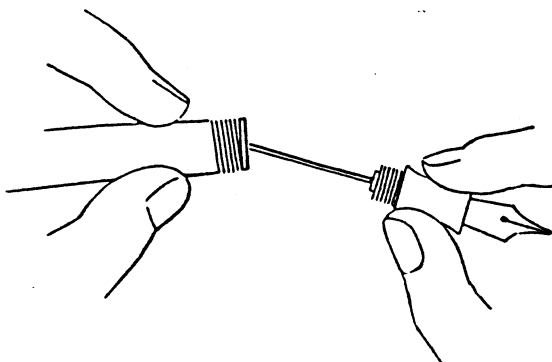

The Vacumatic Pen is fitted with a screw section which is a great aid in servicing and renders exchanging a gold nib very simple.

If a customer wants a nib from one pen put into the holder of another pen of the same size, the necessary exchange can be effected merely by interchanging the complete nib sections.

### VACUMATIC CEMENT

Non-drying Vacumatic cement is applied to the threads of the section. This makes an absolute closure when the section is screwed tightly into the barrel.

If the Vacumatic Cement has hardened in the bottle, it may be softened by heating. When warm, it melts and then is applied more easily. You can heat the cement by leaving the bottle stand for a while in hot water.

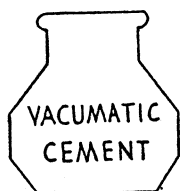

Bottle of  
Vacumatic Cement  
5c net

In fitting the section, care must be taken not to disturb the position of the breather tube. With the section screwed in place, there should be a clearance of 1 to 2 millimeters between the end of the breather tube and the diaphragm. Under no circumstance should the end of the breather tube touch the diaphragm because then the pen will not fill. If the breather tube is too long, a small piece may be clipped off with a pair of scissors.

### FLAT RUBBER

Use a piece of flat rubber whenever you want a tight grip on the pen holder. For instance, to remove the section from the barrel, hold the barrel in one hand and grip the section tightly by means of the piece of flat rubber.

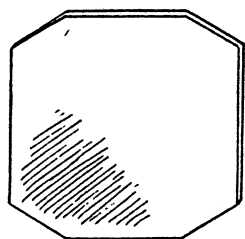

Piece of Flat Rubber  
Size 2½ x 3 inches  
1c net

The cheapest way to obtain this rubber is to cut an inner tube from an old automobile tire into small pieces about 2½" x 3".

## TO REMOVE THE GOLD NIB

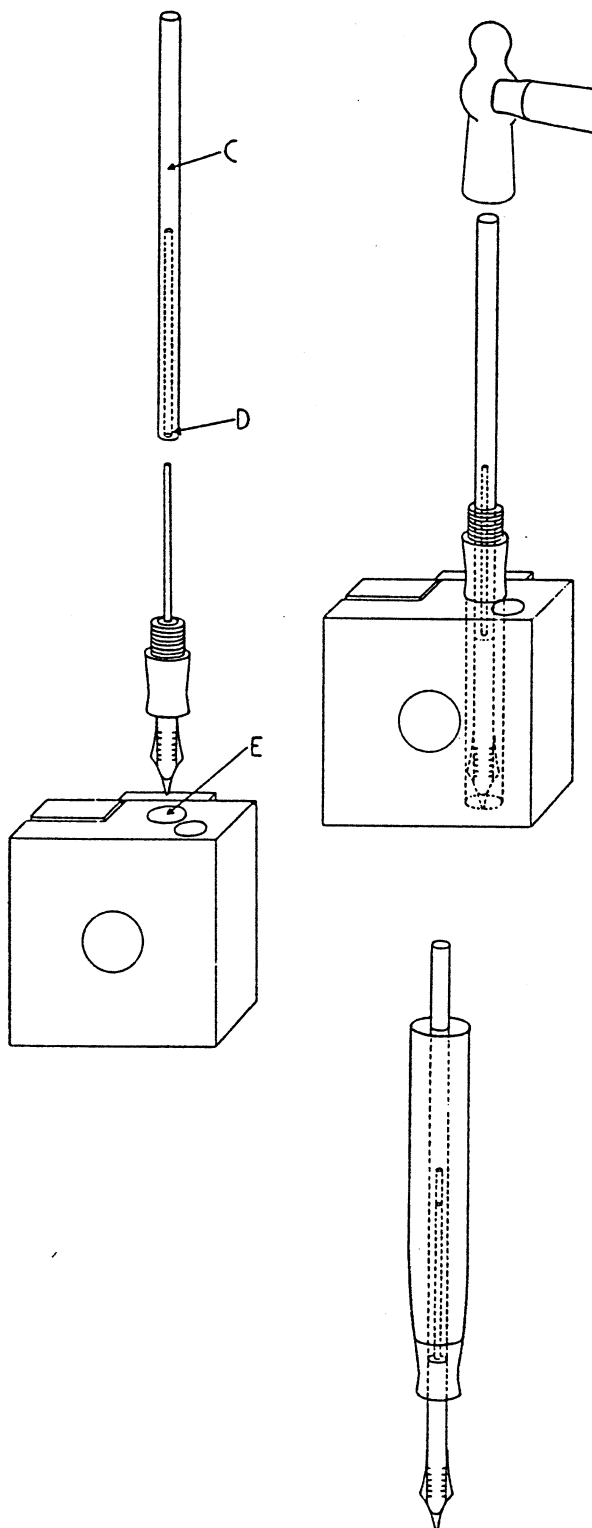

Screw the section from the barrel and place the nib and feed into the collar "E". Slip the channel "D" of the driver "C" over the breather tube and with light taps of a hammer drive out the nib and feed.

Should the Vacumatic pen be of the old style, which has a one-piece section-barrel, the same procedure may be applied although the section cannot be removed. Instead, remove the filler unit and insert the driver "C" from the end of the barrel. The driver "C" was made purposely long enough to fit in one-piece section-barrel pens.

## VACUMATIC FEEDS

Feeds for Vacumatic Pens are made in two styles—

(1) with a narrow ink channel for extra-fine, fine, and medium nibs;

(2) with a wide channel for broad, stub, and oblique nibs. The wide channel provides a greater flow of ink required by these styles of gold nib.

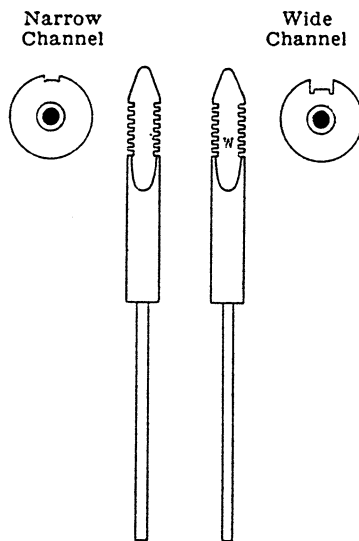

The feeds with wide channel are stamped with the letter "W" so that they may be readily distinguished from the regular feeds.

Vacumatic Feeds are made in four sizes. So that the dealer may tell them apart, we give below exact measurements in millimeters.

	Feed Only mm	Tube Extends mm	Overall Length mm
Oversize	40.4	38.1	78.5
Standard	36.5	37.3	73.8
Junior	36.5	29.3	65.8
Slender	34.2	29.3	63.5

## FLAT BRUSH

To remove dried ink or sediment which has accumulated on feeds, brush the cutting in the feeds with the flat brush which has been dipped in water.



Flat Brush  
25c net

## TO FIT A NEW NIB AND FEED

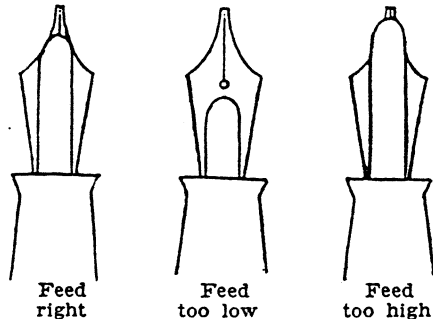

A fountain pen will write satisfactorily only if the feed is correctly fitted.

When the feed is pushed too far into the section, too little ink will reach the nib and the pen will cease writing.

When the feed extends too far out on the nib, ink will flow too freely and the pen will blot.

The Vacuumatic Fitting Block solves this problem by means of three fitting grooves "F" which keep the distance of the nib and the feed in exact relation.

Before fitting the gold nib and the feed, make sure that both are clean. Wash any dried ink from the gold nib and brush the feed channel free of dust particles which might obstruct the flow of ink.

Lay the gold nib over the feed and insert it into the section. In the case of a used pen, the section generally is not perfectly round, but slightly oval in that part where the gold nib had been. In that case turn the section back and forth over the nib and feed to find the "oval position" and push the nib and feed in slightly. The pen is now ready for the Fitting Block.

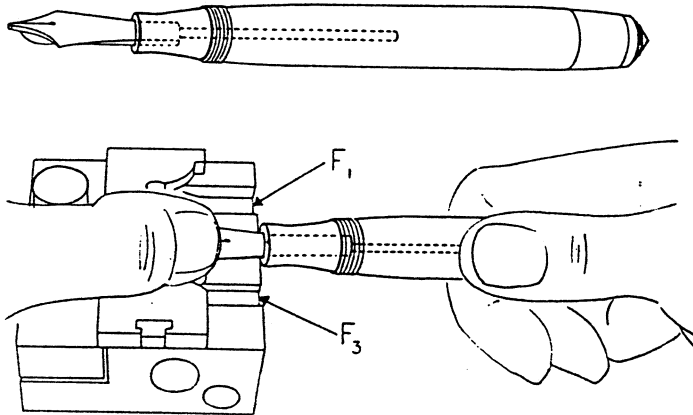

Place the nib and the feed into the corresponding fitting groove "F". Press the left hand thumb tightly on the nib to hold it in place. Grasp the barrel firmly with the right hand and push it with a quick jerk firmly against the block.

## TO "SET" A NEWLY FITTED GOLD NIB

Cross section of nib on feed



A nib close against feed



B nib away from feed

It is necessary that the feed lie snugly and tightly against the gold nib, since a smooth flow of ink will take place only when the nib fits closely against the feed. Illustration A shows the feed tight against the nib. Ink is under control because it is confined to the ink channel in the feed.

Illustration B shows a space between nib and feed. Ink will fill this space and destroy the action of the channel, with the result that the volume of ink and its rate of flow is out of control.

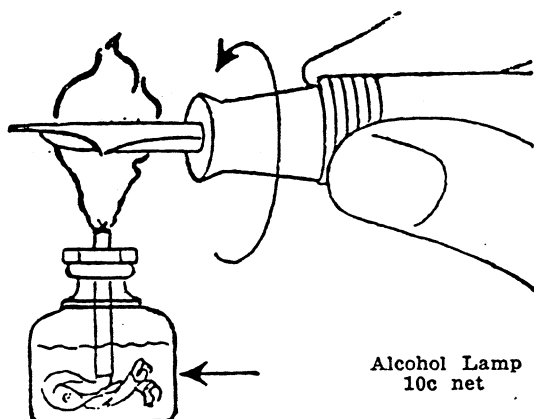

The close fit against the nib is accomplished by "heating down" the feed. Heat the feed by rotating it a few times through a small flame. Do not hold the feed still in the flame and be careful not to burn it. Care should be taken not to get the section near the flame as it may burn.

The simplest means of obtaining a small flame is an alcohol lamp which we can furnish at a net price of 10 cents each.

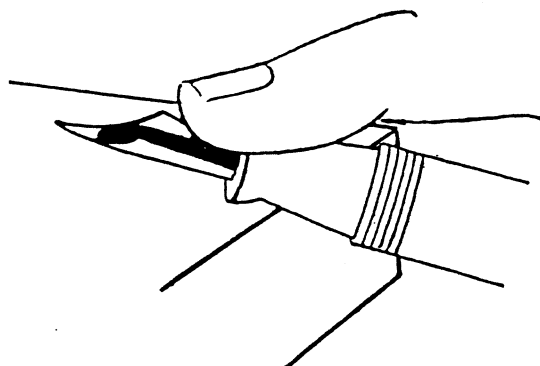

Rest the back of the section on the edge of the table. Dip the forefinger in cold water and rub it back and forth on the warm feed, at the same time pressing the feed tightly against the nib so that the feed will conform to the shape of the nib after the feed has cooled.

## TO REGULATE THE FLOW OF INK

When ink in a pen flows too freely, it may be because the feed is pulled away from the nib. Heating the feed down as described in a previous paragraph will remedy this.

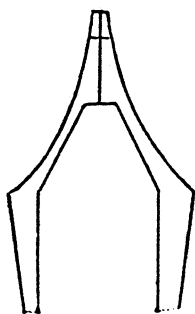

To decrease flow  
bend down and  
close prongs of  
nib.

An excessive flow of ink may be caused by the feed being fitted too high on the nib. Pushing the feed farther into the section will decrease the flow.

A space is left between the prongs of rigid gold nibs to insure an easy flow of ink. When prongs are spread too much, ink will flow too freely; when prongs are closed too tightly, ink will feed only when pressure is exerted.

The flow of ink can be regulated by adjusting the prongs of the gold nib with the thumb nail.

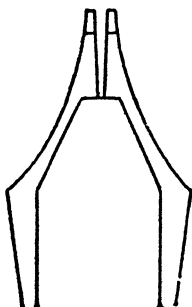

To increase flow  
raise up and  
space prongs of  
nib.

To increase the flow, raise each prong of the gold nib with the thumb nail, one prong at a time. Another method is to place the back of the nib below the air hole against the edge of a desk or table. Then with thumb, press firmly down on the feed. This will loosen the tension of the nib.

To decrease the flow, bend down each prong of the gold nib. This closes the spacing.



## TO REFINISH OR SMOOTH UP THE IRIDIUM TIP

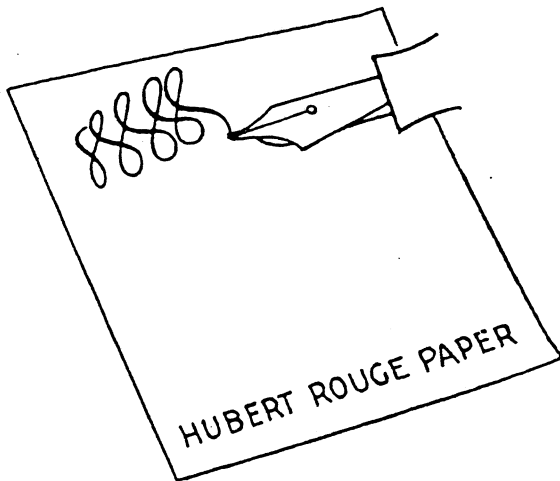

5c net per sheet

Among the employees of a fountain pen repair shop is usually found a man who knows how to smooth up the point of a pen so it will write a little differently from the way the pen writes when sent out by the factory. This is done to suit the particular individual needs of some special customer.

This, however, requires considerable skill and the services of a man who has a thorough understanding of fountain pens and a special knack for doing this kind of work. If this job is done by an inexperienced person, the pen is usually more or less damaged and it would be far better to send the pen to the factory where it could be handled by experts rather than to have it tampered with by amateurs.

In this connection we will say that for anyone who is fitted to repair fountain pens and who wishes to do a certain amount of "smoothing off" to fit the particular needs of some special customer, we have prepared a special kind of smoothing paper known as Hubert Rouge paper which is used in our Repair Department for this purpose. This paper is imported from France and is available at 5c a sheet.

### FLAT NOSE PLIERS

Only an experienced person can adjust the ink flow of the nib with a pair of small pliers. The jaws of these pliers must be especially ground to a thin tip. We can supply them at \$1.35 net each.

Care must be taken to keep pliers away from the iridium tip of nib. An inexperienced person is likely to break off the iridium when trying to bend the prongs with the pliers.

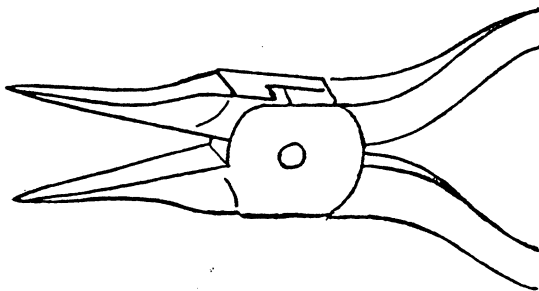

Flat Nose Pliers  
ground to a thin point  
\$1.35 net

## TO REMOVE THE CLIP SCREW

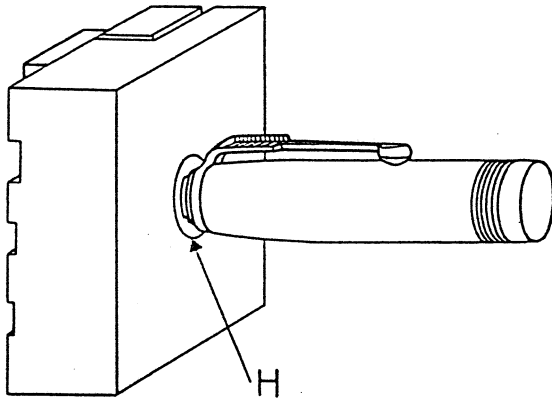

On the underside of the fitting block is a small rubber disc "H". Hold the block in the left hand and press the clip screw firmly against this rubber disc. Give the cap a sharp twist to the left to loosen the clip screw and screw it off.

To tighten the clip screw reverse this procedure.

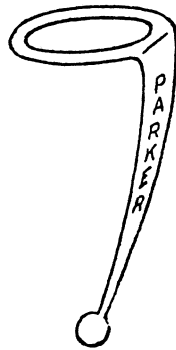

## PARKER CLIP

In time, the clip of any fountain pen will lose its strength or spring quality. Here the Parker Pen has another advantage. When the clip has lost its grip, it is an easy matter to give it new life. Simply remove the clip and bend it to an acute angle. See illustration. When fitted again to the cap, it will be as strong as when the pen was new.

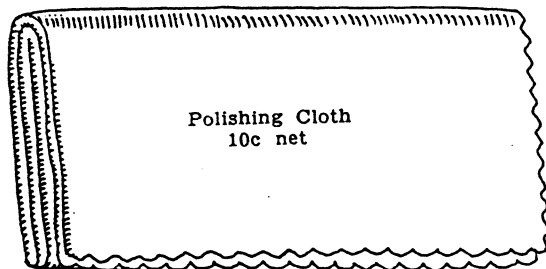

## POLISHING CLOTH

This polishing cloth has been chemically treated; with it you may restore the lustre to the barrels of the pens.

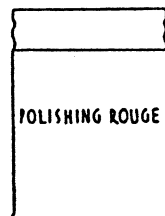

1 Oz. Rouge  
5c net

## POLISHING ROUGE

Apply a small portion of the rouge to a cloth and rub over gold parts such as pen point, gold bands, and clip. The rouge will give the gold parts a high lustre.

PARTS OF THE PARKER DUOFOLD PEN

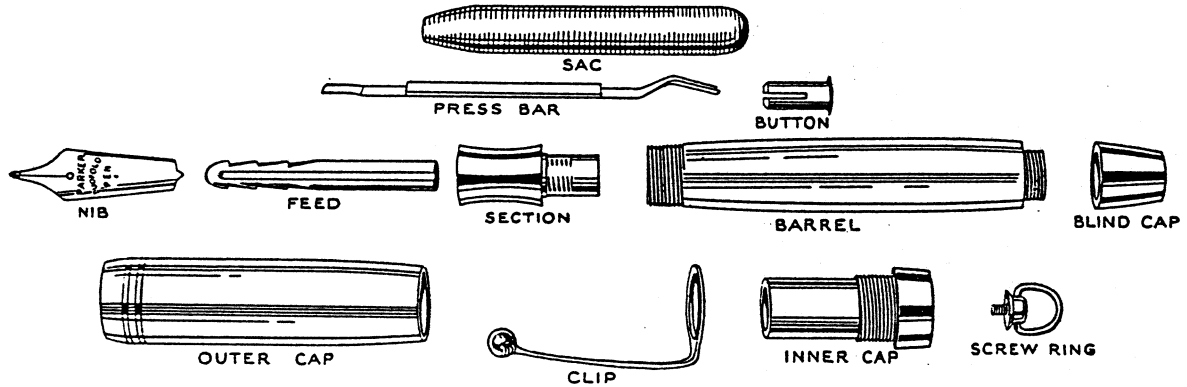

				\$3.50	
	\$7.00	\$5.00	\$5.00	Parker	\$2.50
	Parker	Parker	Parker	Deluxe	Parker
	Duofold	Duofold	Duofold	Challen-	Challen-
	Senior	Junior	Lady	ger	ger
Nib, Solid Gold, Iridium Tip -----	3.50	2.50	2.50	1.50	1.25
Feed, Hard Rubber -----	.15	.15	.15	.15	.15
Section, Hard Rubber -----	.15	.15	.15	.15	.15
Barrel, Pyroxylin -----	1.40	.90	.80	.70	.50
Blind Cap, Hard Rubber -----	.10	.10	.10	.10	.10
Pressure Bar and Button, Bronze_	.10	.10	.10	.10	.10
Sac, Anode Rubber -----	.10	.10	.10	.10	.10
Outer Cap, Pyroxylin,					
Rolled Gold Bands -----	1.40	.90	.80	.70	.50
Inner Cap, Hard Rubber -----	.20	.20	.20	.10	.10
Clip, Rolled Gold -----	.30	.30	.30	.30	.30
Ring, Rolled Gold -----			.30	.30	.30

## TO FILL PARKER DUOFOLD PEN

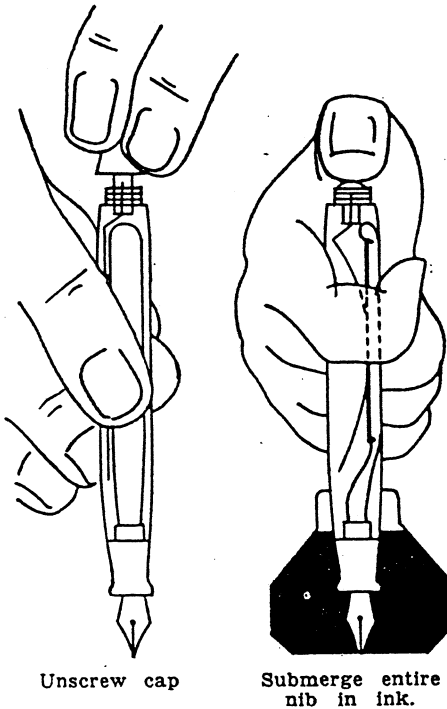

Unscrew the blind cap on the end of the barrel and insert pen in a bottle of good fountain pen ink. It is necessary that the nib and feed be completely submerged in the ink. Press button with thumb to expel all air from ink sac. Release thumb from button instantly and let the nib stay in the ink while you count ten. The ink sac should then be filled.

Be sure to explain to the buyer of a Parker Pen that he must give it time to fill. Some people press the filler-button and withdraw the pen almost immediately after releasing pressure on the button and expect the sac to be filled.

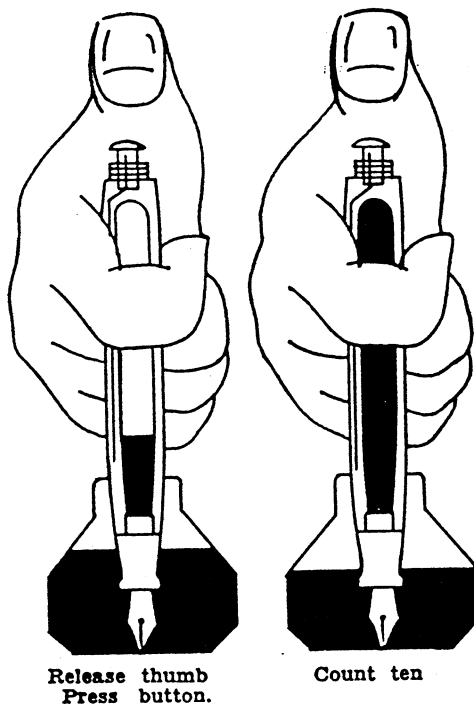

To fill the sac completely, the point should remain immersed in ink at least ten seconds. After ten seconds have elapsed, withdraw the pen from the ink bottle and with a cloth wipe the gold nib clean. Screw blind cap on the pen; it is now ready for writing.

Although all pens are apparently identical some may require more time to fill than others because of minute variations in the dimensions of feed channel or the degree of elasticity of the rubber sac. Thus some pens may need as much as 15 seconds' time to fill completely.

## TO REMOVE THE PRESS BAR

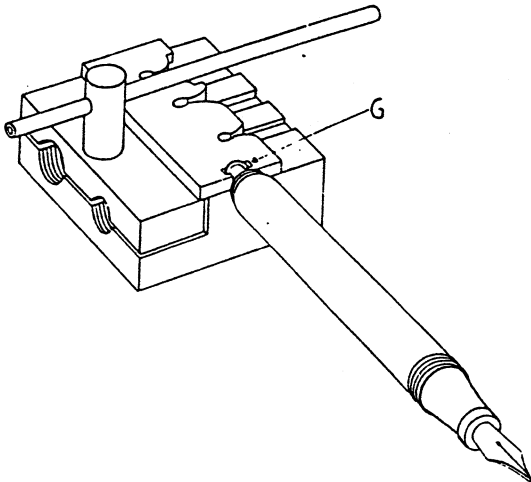

The button puller "G" is used to remove the press button from Parker button-filling pens, such as the Duofold line, Challenger line, etc.

Place the button in the aperture "G" and pull the barrel away.

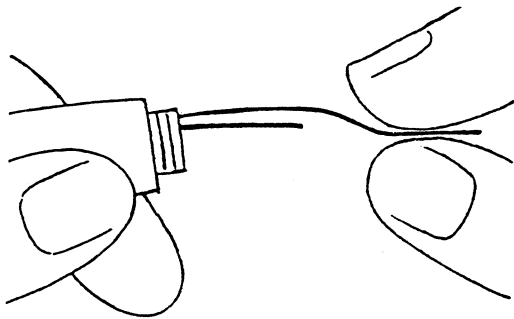

Now remove the pressure bar, pulling it out carefully.

Straight shaped pens have a screw-section; streamlined pens are fitted with a slip-section.

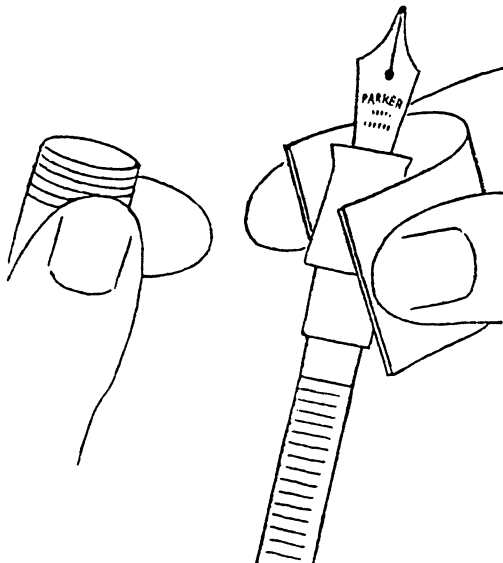

Before removing the section from the barrel, tap the barrel at the threads with a blunt tool or hit the barrel against the edge of a table; this will loosen the shellac which was used in fitting the section. Then with a piece of rubber (cut from a wide rubberband) grip the section tightly. If it is a screw section, unscrew it; if it is a slip section pull it out with a rocking motion.

## SACS

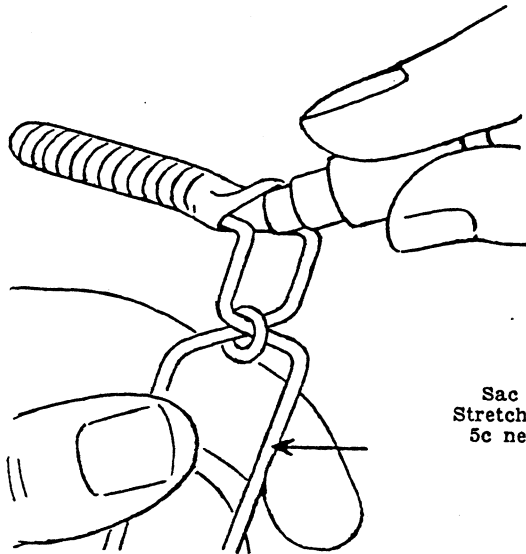

Sac  
Stretcher  
5c net

In repairing a Duofold pen it is important that it be fitted with the correct size of sac. We show below the various sacs for the different sizes of pens. As sometimes it may be difficult to determine the required size, the exact measurements of the sacs are also indicated.

Sacs	Length List Price .10	Length Inches	Length m/m	Diam. m/m
Senior	-----	2½	63	9
Special	-----	2½	63	8
Long	-----	2½	63	7
Intermed.	-----	2¼	57	8
Short Junior	--	2	51	8
Lady	-----	2	51	7
Pastel	-----	2	51	6
Midget	-----	1½	37	7

### TO ATTACH RUBBER SAC

Put a little shellac on the nipple of section. Spread mouth of sac with the sac spreader and slip the sac on the nipple. Be careful not to get any shellac in the feed channel.

If rubber sac should be too long, cut off surplus.

Now put a little shellac on that part of section which touches the inside wall of barrel. Insert sac carefully and push section into barrel.



Bottle Shellac  
5c net

### FLAT FILE

A file comes in handy in a repair department for various smoothing-up operations, such as removing particles of ink or shellac from the nipple of the section. Sometimes pressure bars will be too long for some of the old style holders, making it necessary to cut off a little; the edges of the bar should be filed smooth.



Flat File  
20c net

## PRESSURE BARS

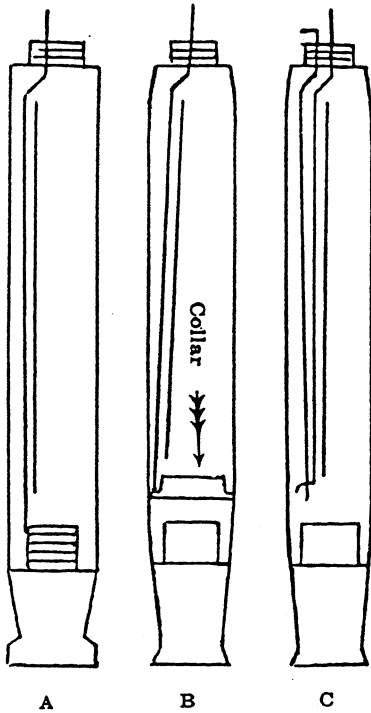

A Duofold Pen may be fitted with one of three kinds of Pressure Bars:

A—Screw Section Bar, which was used for the straight shaped pens and was so named because it rested against the screw section. The section screws into the barrel.

B—Slip Section Bar, which is used for Streamline pens with a metal ring or "collar" inside the barrel. The bar rests against the "collar."

C—Triple Bar, which eliminates the presence of a "collar." This bar is now regularly fitted in button-filling Parker Pens.

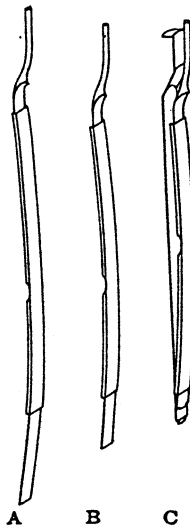

Pressure Bars	Length	Length
List Price .10	Inches	m/m

## Screw Section Bar—

Long	-----3 $\frac{3}{8}$	84
Short	-----2 $\frac{5}{8}$	65
Midget	-----1 $\frac{7}{8}$	48

## Slip Section Bar—

Long	-----2 $\frac{3}{4}$	70
Short	-----2 $\frac{1}{4}$	57

## Triple Bar—

Long	-----2 $\frac{3}{4}$	69
Intermediate	-----2 $\frac{1}{2}$	62
Short	-----2 $\frac{1}{4}$	56

## TO INSERT THE PRESSURE BAR

Care must be taken when inserting the pressure bar that the small plate of the bar faces the sac.

Bend the front end of the bar upwards toward the wall of the barrel. Make sure when you push the bar in, that the ink sac will not be telescoped. See illustration.

After the pressure bar is properly fitted, replace the pressure button. Check that the pressure bar works properly by holding the pen close to the ear and pressing the button. You should feel a whiff of air escaping through the airhole in the gold nib.

Pressure bar inserted

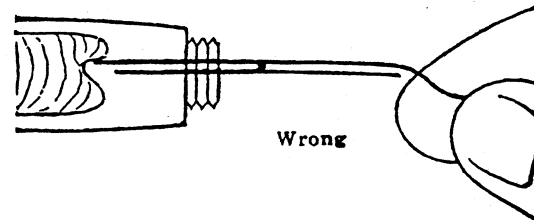
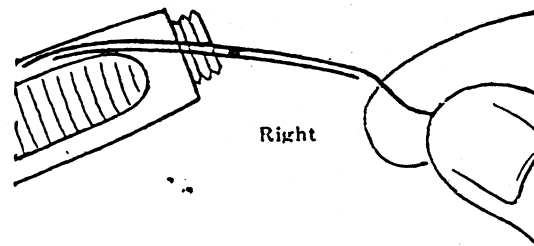

## BERNARD PLIERS

A handy tool to have in the repair department is a pair of Bernard pliers.

This style of pliers has the jaws arranged in such a fashion that when they open they always keep in parallel position instead of opening with an angle as is the case with ordinary pliers.

These Bernard pliers are especially useful in fitting gold nibs into pens. It is important that a piece of rubber tubing be inserted between the jaws to protect the gold nib from damage.

We can supply the Bernard pliers at \$1.35 net, and rubber tubing at 2 cents net per piece.

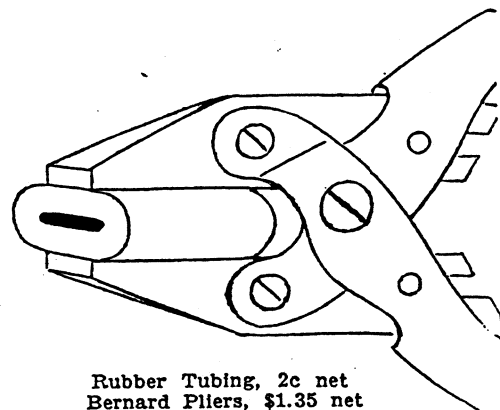

Rubber Tubing, 2c net  
Bernard Pliers, \$1.35 net



## LEAKING

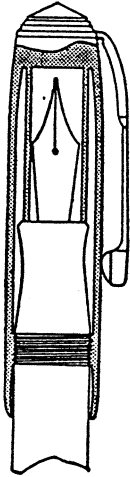

“Leaking” is a term applied to two different conditions:

(1) If the cap of the pen is not screwed on securely when not in use, the ink may ooze out of the feed and soil the inner wall of the cap. When the user later unscrews the cap, his fingers may be soiled with the ink which has accumulated on the threads of the barrel and he will complain that his pen “leaks”.

The purpose of the cap is to effect a hermetic sealing which makes the escape of ink impossible. To accomplish this, the cap must be screwed on until a “click” is heard. The click is produced by the tight closure of the inner cap over the section.

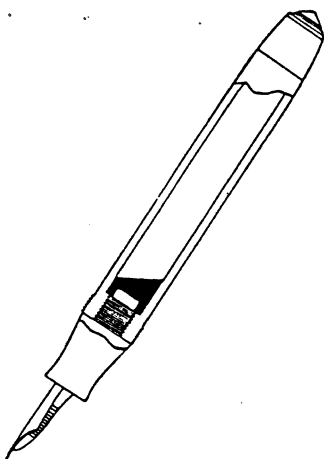

(2) When a pen is almost empty and needs refilling, ink will flow faster than normally. This is true with any fountain pen when the volume of air in the barrel is relatively much greater than the volume of ink. Air is highly expansible and the warmth of the hand expands the air in the barrel and forces the ink out through the feed channel. This is probably the basis for most complaints about “leaking” or “flooding”—it is really a signal to refill the pen which, of course, stops the trouble.

## PROPER CARE OF YOUR FOUNTAIN PEN

The fountain pen is a delicate instrument and should be treated as such. Never fill your pen from an ink bottle which has stood uncorked for some time or from ink which contains sediment, for dust and dirt particles will clog the fine ink channel in the feed.

In the course of time it is quite natural that even with use of the best ink some small particles of sediment will enter the ink sac and obstruct the flow of ink through the channel.

It is, therefore, necessary to clean the fountain pen from time to time in order to keep it in good condition. This cleaning process is very simple. Fill a tumbler with cold water, insert the pen just as for filling, fill the sac with water and expel it again. Repeat this flushing operation four or five times to wash away all sediment in the channel. To insure thorough cleansing of the pen, fill the pen with water and let it stand point down in a tumbler of water over night. This dissolves and removes all ink crusts.

Never flush with hot water because it ruins the sac and expands the feed.

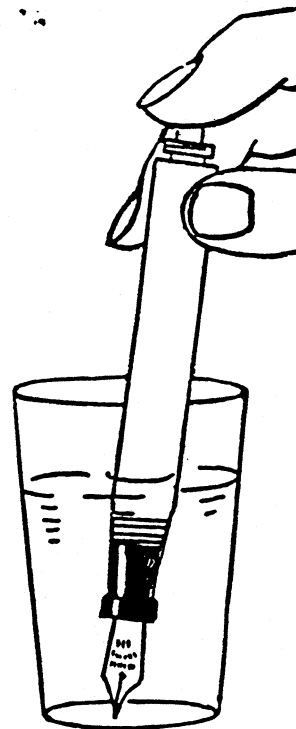

## ROUND BRUSH

The round brush is used to clean dried ink and dirt from the inside of the cap and the barrel.



Round Brush  
10c net

# PARKER REPAIR TOOL CABINET No. 966

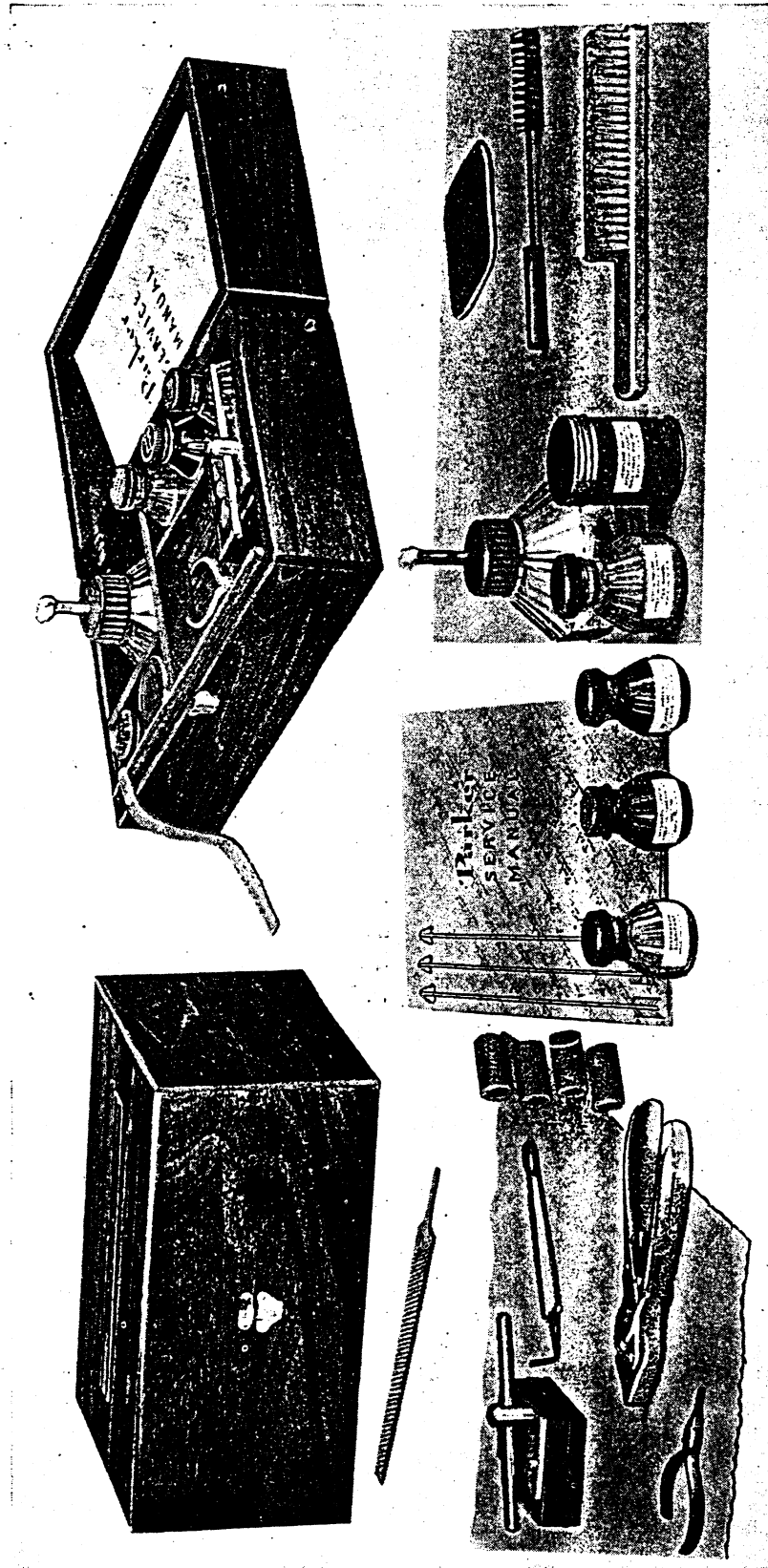

The Repair Tool Cabinet No. 966, illustrated above, contains the necessary tools to satisfactorily repair all Parker pens. The cabinet is made of wood and measures approximately 9¼ x 6¼ x 4½". Its weight complete is 4½ lbs. When ordered complete with all tools, its price is \$6.00 net.

Contains:	Price Net	Price Net
1 Vacuumatic Fitting Block -----	\$1.50	.05
1 Bernard Pliers -----	1.35	.05
1 Flat Nose Pliers, thin point -----	1.20	.05
1 Flat Brush, for feeds -----	.25	.05
1 Flat File -----	.20	.05
1 Round Brush, for caps -----	.10	.04
1 Alcohol Lamp -----	.10	.01
1 Polishing Cloth -----	.10	1.50
1 Hubert Rouge Paper -----	.05	1.50
1 Bottle Vacuumatic Cement -----	.05	1.50
1 Bottle Diaphragm Lubricant -----		.05
1 Bottle Shellac, for sacs -----		.05
1 Bottle Liquid Polish -----		.05
1 Oz. Rouge, gold polish -----		.05
1 Sac Stretcher -----		.05
4 Pieces Rubber Tubing @ .01 -----		.04
1 Piece flat rubber, 2½ x 3 -----		.01
1 Wood Cabinet -----		1.50
1 Service Manual No. 115, 1 Part Price List No. 116 -----		1.50
Total -----		Net \$6.70

Special Price complete \$6.00 net.

## QUINK KEEPS A PEN CLEAN



Parker Quink  
2 oz. 15c  
4 oz. 25c

For best results, use Quink, the new ink, which contains a harmless secret solvent to dissolve sediment left in the pen by other inks.

By the regular use of Parker Quink, indelible ink stains in the barrel can be avoided, because Quink's secret solvent keeps the pen clean.

### TO REMOVE STAINS INSIDE THE BARREL

For a safe, general purpose cleaner to remove ink stains from the inside of the barrels of Transparent VACUMATIC Pens, flush the pen with vinegar.

The vinegar cleans the inside wall and leaves the barrel transparent. Remove all trace of the vinegar by flushing the pen several times with water, before filling it with ink.

### TO REMOVE STAINS ON BARREL

Moisten a piece of tissue paper and put some good tooth paste on it. Rub the soiled part and see how easily the stain is removed.



Bottle of  
Liquid Polish  
5 cents

### LIQUID POLISH

To restore a high lustre to the pen barrel apply liquid polish so that it forms a thin coat over the entire pen holder. Allow to dry for a few seconds; then rub the pen well with a dry soft cloth until it is dry.

PARTS OF THE PARKER PENCIL

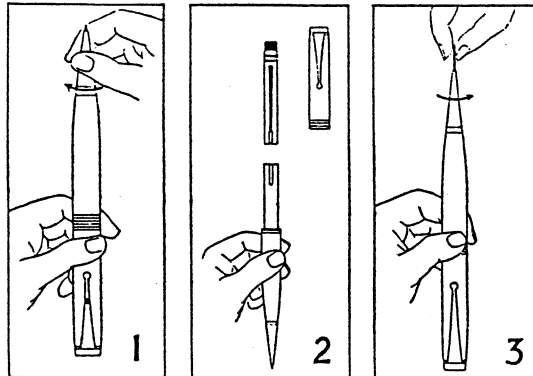
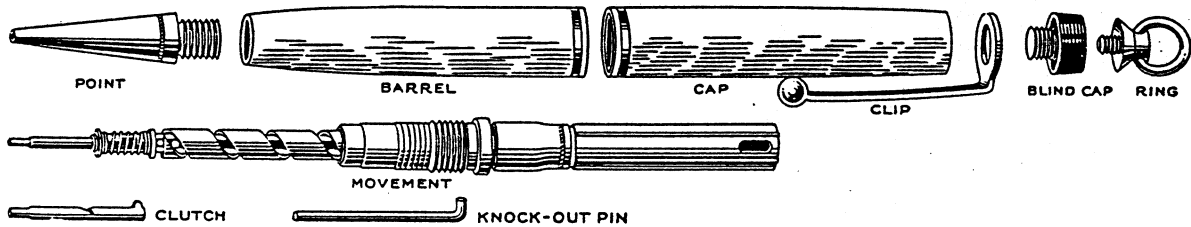

THE PARKER LEAD CARTRIDGE

The leads and the eraser in Parker Pencils are contained in a special cartridge. The entire cartridge may be removed and a new one inserted, thus insuring you of receiving best quality leads and a fresh eraser, at all times.

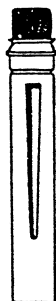

Lead Cartridge  
10c  
11st

Parker Lead Cartridges with eraser included come in seven grades, from extra soft to very hard; also in four colors—blue, green, red, and indelible.

Price of Parker Lead Cartridge is 10 cents list.

## PARKER DESK SETS

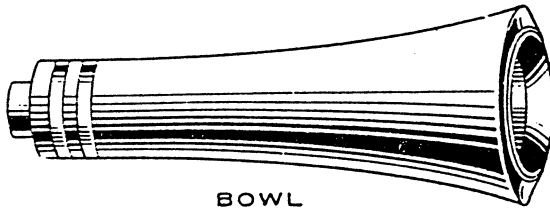
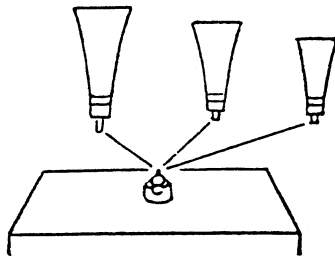

BOWL

RETAINER

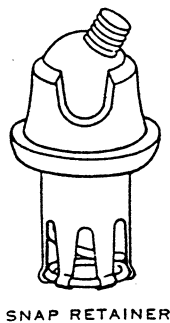
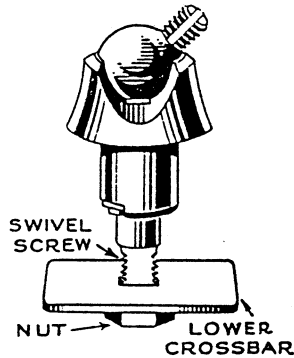

SNAP RETAINER

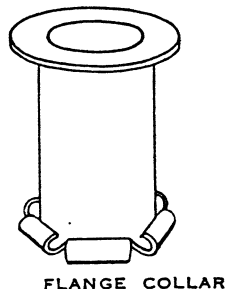

FLANGE COLLAR

The Parker desk set consists of a base and a socket.

The socket is divided into two parts; the retainer, which is fastened to the base, and the bowl, which is the receptacle for the pen.

The bowl is available in three sizes: Oversize, Standard, and Lady. Each of the three sizes is made for either a pen or a pencil.

### BOWLS

The bowls are interchangeable. If a base happens to be fitted with a standard size bowl, and the pen to be used with it is a Lady size, simply screw off the Standard size bowl and substitute a Lady size bowl.

The List price of the bowl is 80c, the list price of the retainer is 80c, and the list price of a complete socket is \$1.60.

### RETAINERS

There are two types of retainers:

1. The screw retainer which is fastened to the base by means of a swivel screw.
2. The snap retainer which by means of a spring snaps into a flange collar in the base.

The screw retainer consists of the retainer, swivel screw, lower cross bar, and nut. When ordering parts for the screw retainer, it is important to specify the exact length of the swivel screw needed, that is,  $\frac{5}{8}$ ",  $\frac{3}{4}$ ", etc.

The snap retainer consists of the retainer and the flange collar. The flange collar is one inch deep.

## TO ATTACH THE RETAINER TO THE BASE

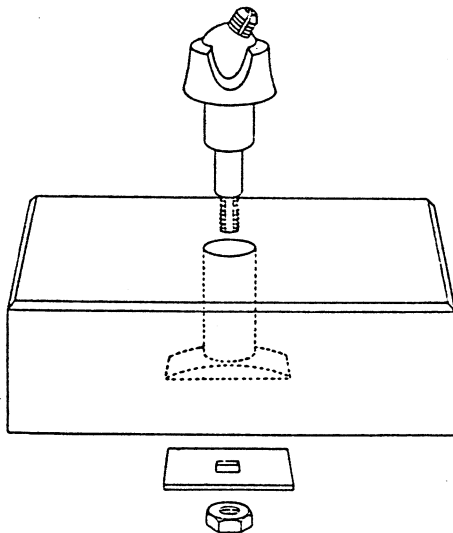

1. **Screw retainer.** The hole drilled in the base is  $5/16''$  or 8.3 mm. in diameter. At the bottom of the base a groove is cut to accommodate the crossbar, as shown in the illustration.

Put the lower end of the retainer with the swivel screw through the hole in the base. Turn the base upside down and slip the crossbar over the swivel screw and screw it tight with the nut.

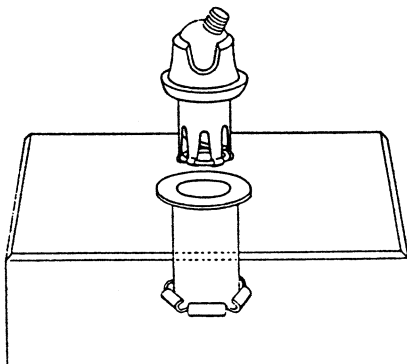

2. **Snap retainer.** The hole drilled for the flange collar is  $7/16''$  or 11.1 mm.

The flange collar is fixed to the base by means of a hand press and a special tool which splits and rolls up the ends of the collar.

It would be possible to cement the flange collar into the hole in the base. In that case the collar must be cut off to shorten it to the same depth as that of the base.



## THE PARKER DESK SET IN OPERATION

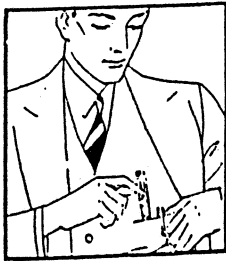

To change your Pocket Parker to a Desk Parker—



Remove the pocket cap with clip.



Substitute the tapered tip (free with desk base).

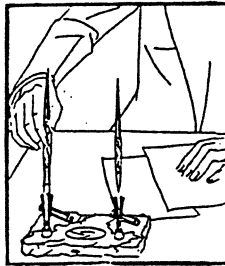

Use your favorite pocket pen as a desk pen.

Gold spring ring holds pen firmly in socket

Socket can be changed in a jiffy to suit any size Duofold Pen

Pen Socket. Construction is almost exactly similar to leak-proof Pocket Cap. Inner sleeve protects nib from harm and keeps a tiny droplet of ink always ready for instant writing

Pen lies level without drying

Retainer Assembly housing Ball and Socket Joint allows pen to swing in any direction or lie flat

Desk Base in wide choice of materials

